

Disposable Trocar

- Durable universal seal, no reducer needed
- Threaded design maximizes abdominal wall retention
- Recessed stopcock valve
- Autosield / Optical / Bladeless



Disposable Trocar



Auto-shielded 101Y402 5×100mm
101Y405 10×100mm
101Y407 12×100mm



Bladeless 101Y202 5×100mm
101Y205 10×100mm
101Y207 12×100mm



Optical 101Y301A 3×65mm
101Y303A 5×70mm
101Y302 5×100mm
101Y305 10×100mm
101Y307 12×100mm



Optical 101Y602 5×100mm
101Y605 10×100mm
101Y607 12×100mm



Disposable Trocar (Hasson)

- Durable universal seal, no reducer needed
- Recessed stopcock valve
- Unique fixing design
- Optical / blunt tip



Obturator For Hasson Trocar

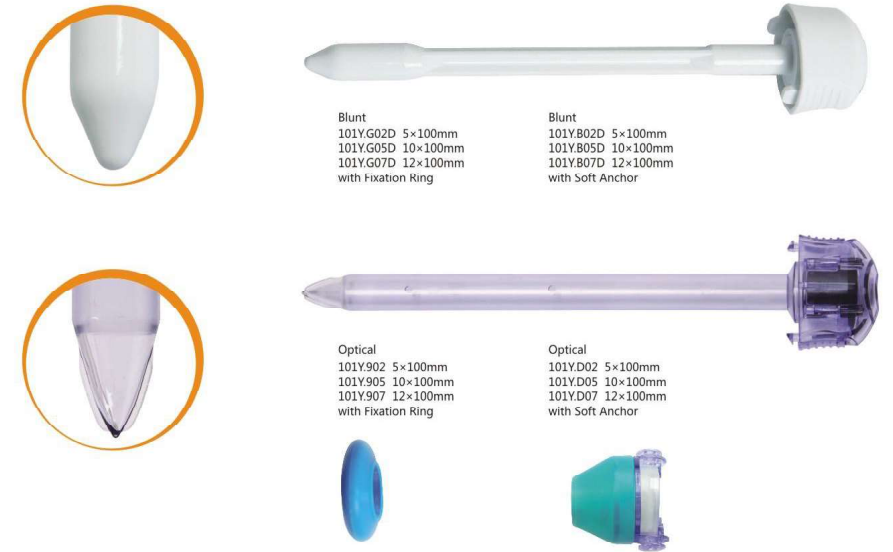

Disposable Pediatric Trocar

- Designed for Infants
- Smaller OD
- Stainless steel cannula



Disposable Trocar (Single Port)

- Ensure a large floating angle for instruments
- Soft material with nice leak proofness
- Easy to get tissues out of the bigger opening
- Simple design to ensure an easy assembly and disassembly
- No extra scars left after surgery



Wound Protector: ODΦ70mm



Trocar Cannula: IDΦ6/Φ11/Φ13mm

Specification

101Y.F53	Cannula(Φ5×2, Φ10×1, Φ12×1) +Wound Protector
----------	--

Disposable Thoracoscopic Trocar



101Y.510 Φ6×65mm

101Y.512 Φ10×65mm

101Y.513 Φ12×65mm

Disposable Orthopedics Trocar



101Y.553 Φ8×120mm

101Y.552 Φ8×100mm

101Y.551 Φ6×120mm

101Y.550 Φ6×100mm

Disposable Veress Needle

- Big size spring-loaded stylet provides loud audible "click" when passing through tissue layers
- Visible red indicator of needle position.
- Sharp tip for easy insertion.
- High flow stopcock
- Two sizes with 120/150 mm length are available.

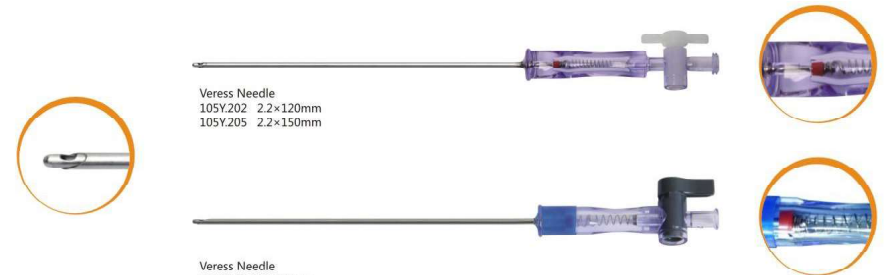

Veress Needle
105Y.202 2.2×120mm
105Y.205 2.2×150mm

Veress Needle
105Y.208 2.2×120mm
105Y.209 2.2×150mm

Disposable Laparoscopic Instrument

- Light, well balanced
- Smooth rotation of jaws
- Comfortable easy open and close handle
- Double hinge design insure maximum jaw opening and accurate jaw motion
- Colors of reel could be customized.



106Y.201 Curved Scissor, High-insulation(17mm)

106Y.203 Curved Scissor, High-insulation Short Blade(12mm)



Disposable Bipolar

- Unified handle for same hand feeling
- Exceptional safety and security
- Integrated cable



109Y.201 Straight

109Y.202 Curved

Disposable Monopolar HF Electrode



Hook 110Y.101 without cable
110Y.201 with cable

Disposable Monopolar HF Electrode with Smoke Suction



Spatula 110Y.502

Hook 110Y.401

Disposable Bipolar with Cutting

- Unified handle for same hand feeling
- Exceptional safety and security
- Coagulate, cutting
- With ratchet system
- Integrated cable



109Y.601 Straight

Reusable Instrument (Disposable Shaft + Reusable Handle)

- Economical
- Perfect compatible with reusable handle

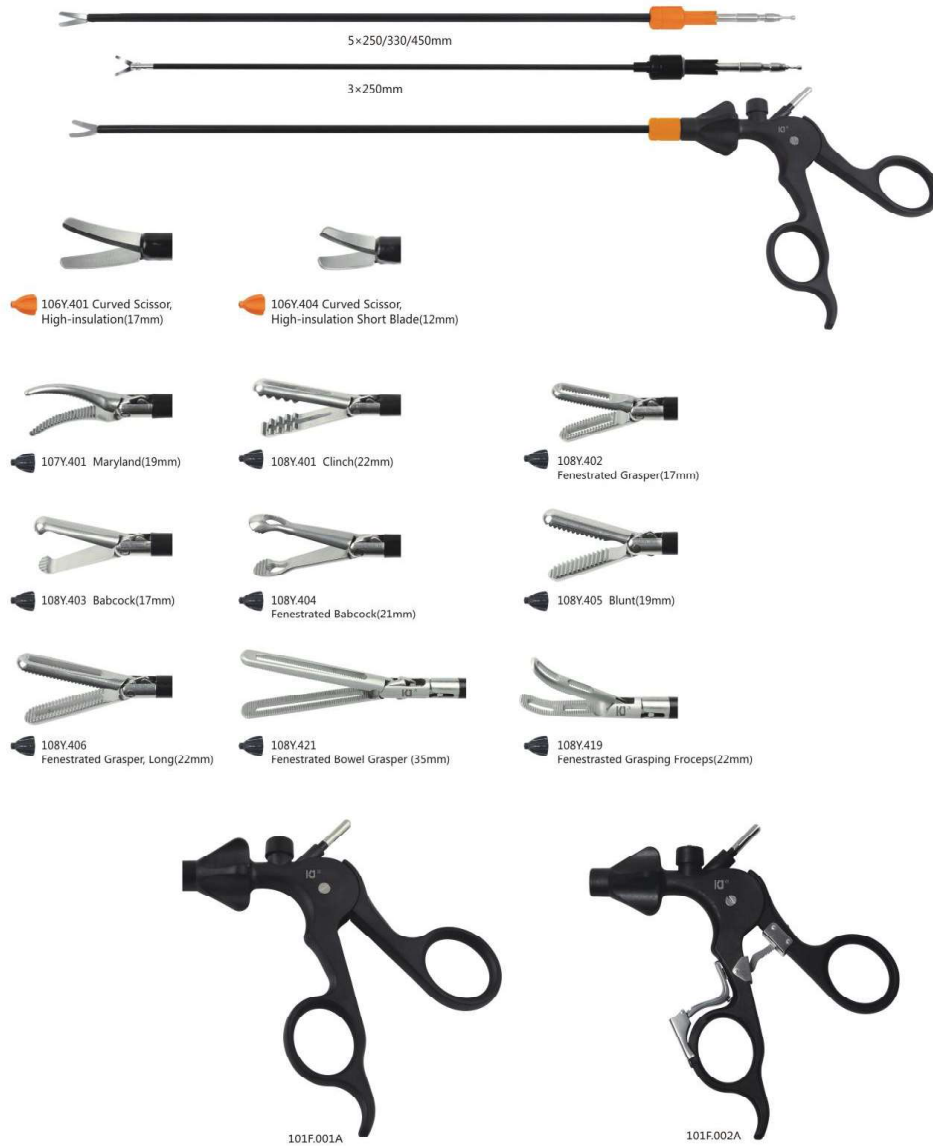

Disposable Retrieval Bag

- Nitinol spring for extra-strength
- TPU bag for superior durability
- Exceptional safety and security

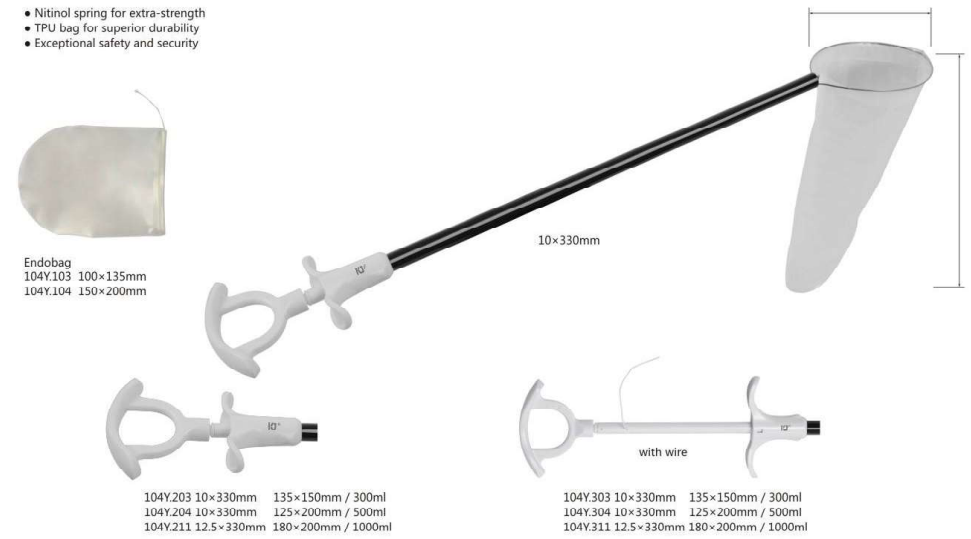

Disposable Suction / Irrigation

- Quick probe exchange
- Phthalate free of PVC tubing set
- Transparent hand-piece for visualization of fluid
- Superior ergonomically designed for both right and left hand

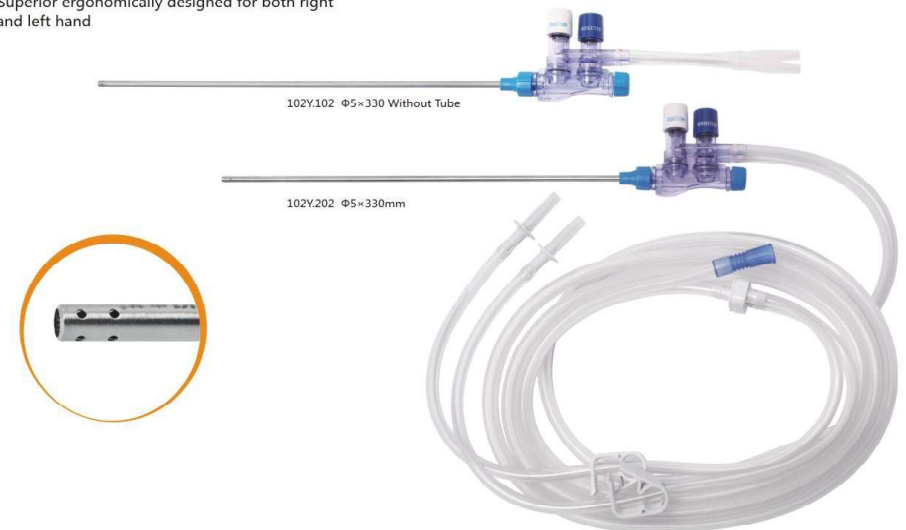

Trocar



Silicon Sealing
101.003 Φ5.5×95mm
101.004 Φ10.5×95mm
101.008 Φ12.5×95mm



Magnetic Ball
101.003B Φ5.5×95mm
101.004B Φ10.5×95mm



Manual Lever
101.003A Φ5.5×95mm
101.004A Φ10.5×95mm
101.008A Φ12.5×95mm



Magnetic Sheet
101.003C Φ5.5×95mm
101.004C Φ10.5×95mm
101.008C Φ12.5×95mm



Manual Lever
101.257 Φ5.5×95mm
101.256 Φ6×95mm
101.255 Φ10.5×95mm
101.254 Φ11×95mm

- Each type apply to un-threaded / threaded cannulae
- Each type apply to pyramidal / autoshield / oblique autoshield tip



Pyramidal

Autoshield

Oblique Autoshield

Un-threaded

Threaded



Trocar
201.008 Φ5.5mm
201.009 Φ8.5mm
201.010 Φ10.5mm
201.011 Φ12.5mm



Trocar
101.108 Φ5.5×88mm
101.109 Φ10.5×88mm

Reducer



Φ10.5-Φ5.5 150mm
Sleeve
101.010-100 Φ10.5-Φ5.5 100mm
101.010-120 Φ10.5-Φ5.5 120mm
101.010-150 Φ10.5-Φ5.5 150mm
101.010-180 Φ10.5-Φ5.5 180mm



Adapter
101.145 Φ10.5-Φ5.5mm



Adapter
101.146 Φ10.5-Φ5.5mm

Sealing Cap



Sealing Cap
104.002-1001 3mm



Sealing Cap
101.003-1001 5mm



Sealing Cap
101.004-1001 10mm

Veress Needle



Veress Needle
101.011 Φ2.2×110mm
101.011A Φ2.2×120mm
101.011B Φ2.2×150mm



101.231 Connector (Small)



101.232 Connector (Medium)

Aspiration Needle

Aspiration Needle
101.027 Φ5×330mm



7# 101.027A

9# 101.027B

12# 101.027

16# 101.027C

18# 101.027D

20# 101.027E

22# 101.027F

Bile Duct Scalpel



101.025



101.025A



101.025 Bile Duct Scalpel Φ5×330mm



101.026 Bile Duct Scalpel Φ10×330mm

Polymer Ligation Clip, Clip Applier



6 pcs / cartridge, 14 cartridges / box



Clip Applier For Open Surgery

For XL Clips
 101.115-9 200mm-9°
 101.115-30 250mm-30°
 101.115-70 280mm-70°



For L Clips
 101.115A-9 200mm-9°
 101.115A-30 250mm-30°
 101.115A-70 280mm-70°



For ML Clips
 101.115B-9 200mm-9°
 101.115B-30 250mm-30°
 101.115B-70 280mm-70°



Clip Remover



For L Polymer clips
 101.131 Φ5.5×330mm

Titanium Ligation Clip, Clip Applier



6 pcs / cartridge, 20 cartridges / box

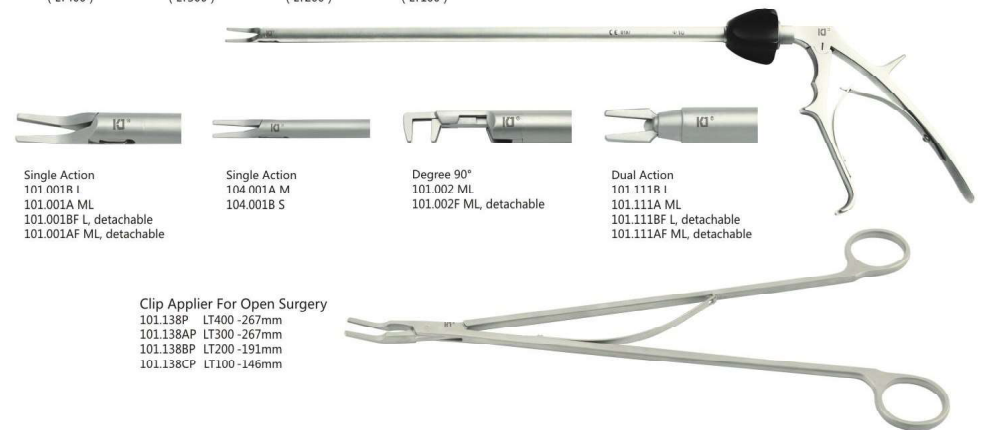

Artery/Vein Clip, Clip Applier



Needle Holder

"O" Shape $\Phi 5 \times 330\text{mm}$

- 101.022 Straight
- 101.022A Curved
- 101.022B Self-righting
- 101.022C Self-righting
- 101.022D Self-righting

Pistol $\Phi 5 \times 330\text{mm}$

- 101.102 Straight
- 101.102A Curved
- 101.102B Self-righting
- 101.102C Self-righting
- 101.102D Self-righting

"A" Shape, Vertical $\Phi 5 \times 330\text{mm}$

- 101.244 Straight
- 101.244A Curved
- 101.244B Self-righting
- 101.244C Self-righting
- 101.244D Self-righting

"V" Shape $\Phi 5 \times 330\text{mm}$

- 101.024 Straight
- 101.024A Curved
- 101.024B Self-righting
- 101.024C Self-righting
- 101.024D Self-righting
- 101.024F Straight Detachable



• 3-piece detachable type is available



Knot Pusher

Without Suture Opening
101.029 $\Phi 5 \times 330\text{mm}$

With Suture Opening
101.029B $\Phi 5 \times 330\text{mm}$

Closure Forceps

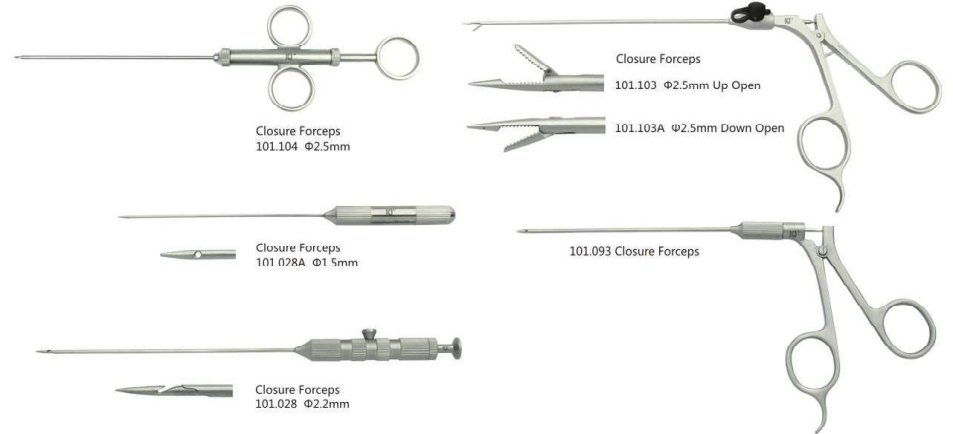

Purse Stitching Clamp

101.132D Purse Stitching Clamp for laparoscopic surgery



101.132 Purse Stitching Clamp for open surgery



Colon and Rectum Instruments

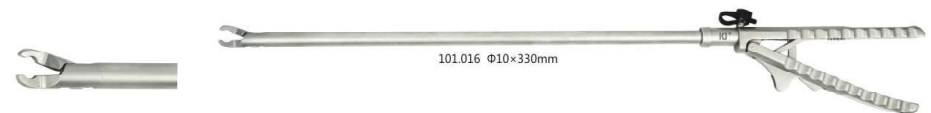

Retractor



Golden Finger

101.096 Golden Finger $\Phi 5.5 \times 460\text{mm}$

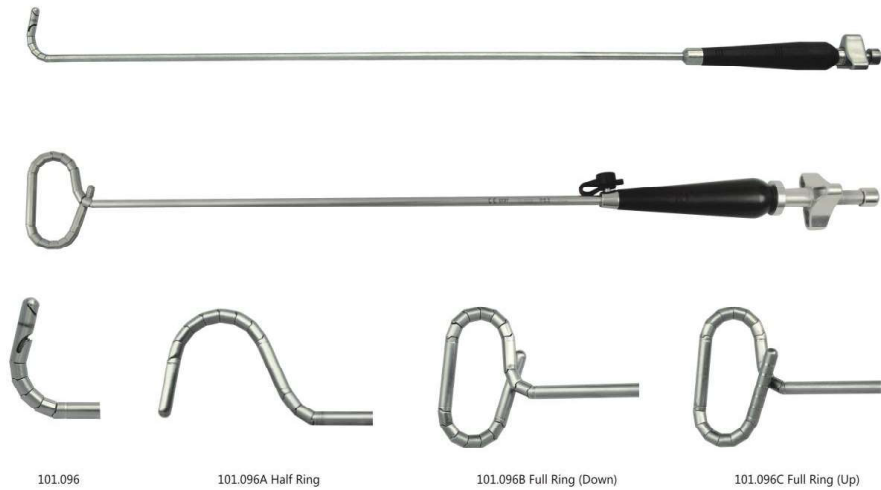

Artery /Nerve Retractor

101.106 Artery /Nerve Retractor $\Phi 10 \times 330\text{mm}$



Retractor

101.066 Retractor



Spring Grasping Forcep



Cholangiography Forcep

101.063 Cholangiography Forcep
 $\Phi 5 \times 330\text{mm}$



Articulating Instrument



Biliary-Lithotomy Forcep



Suction / Irrigation

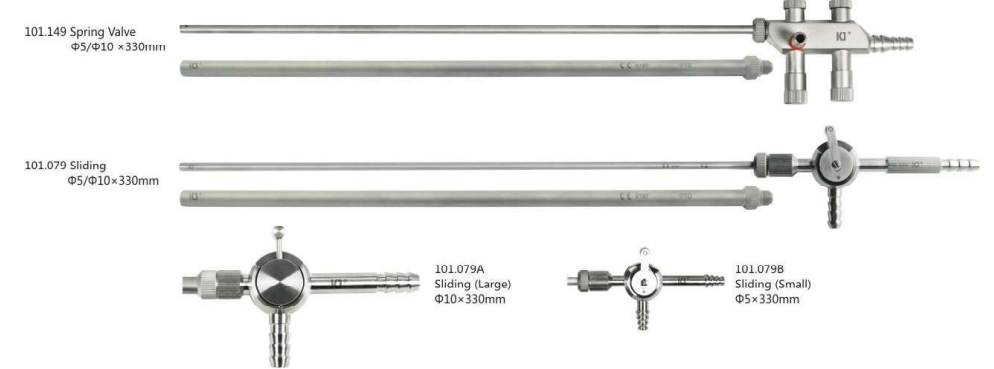

Bipolar

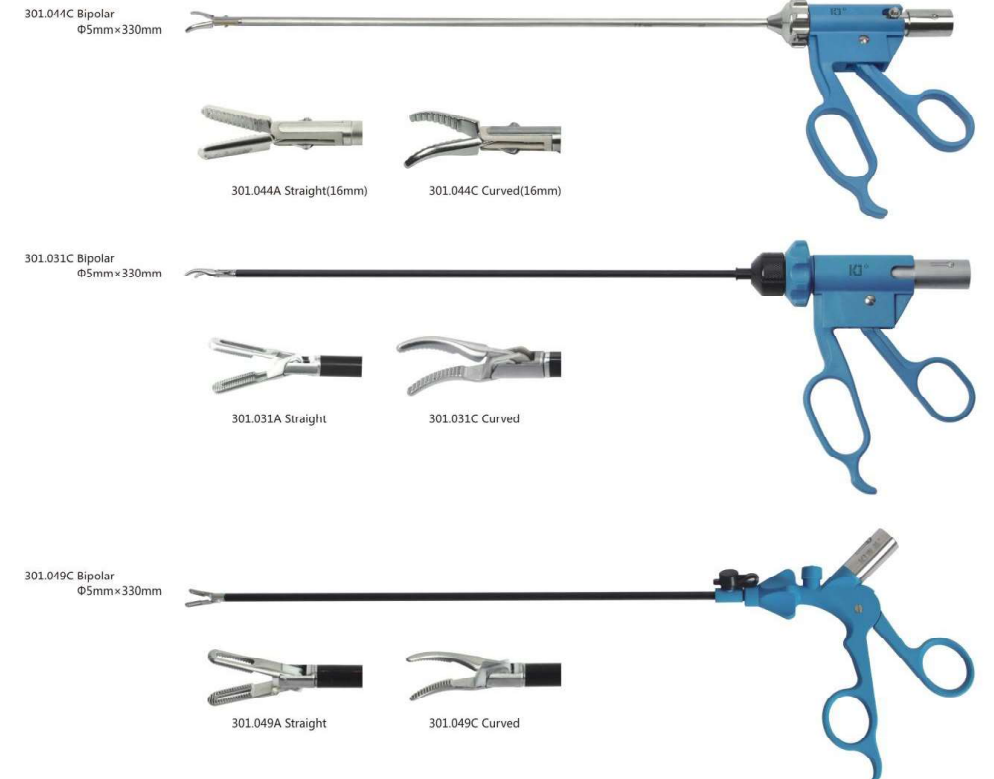

Monopolar HF Electrode



Monopolar HF Electrode with S&I

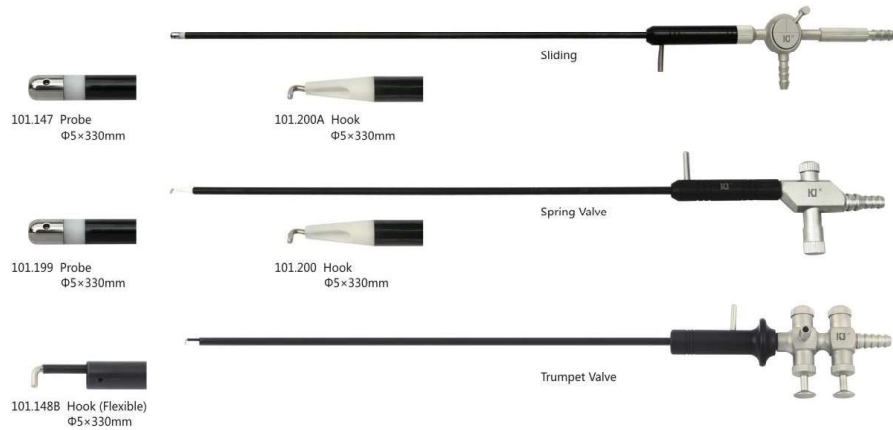

Cord



Handle



5MM Scissor

Working Length: 330mm/360mm/450mm



5MM Dissector

Working Length: 220mm/330mm*/450mm *Regular



5MM Grasper

Working Length: 220mm/330mm*/450mm *Regular

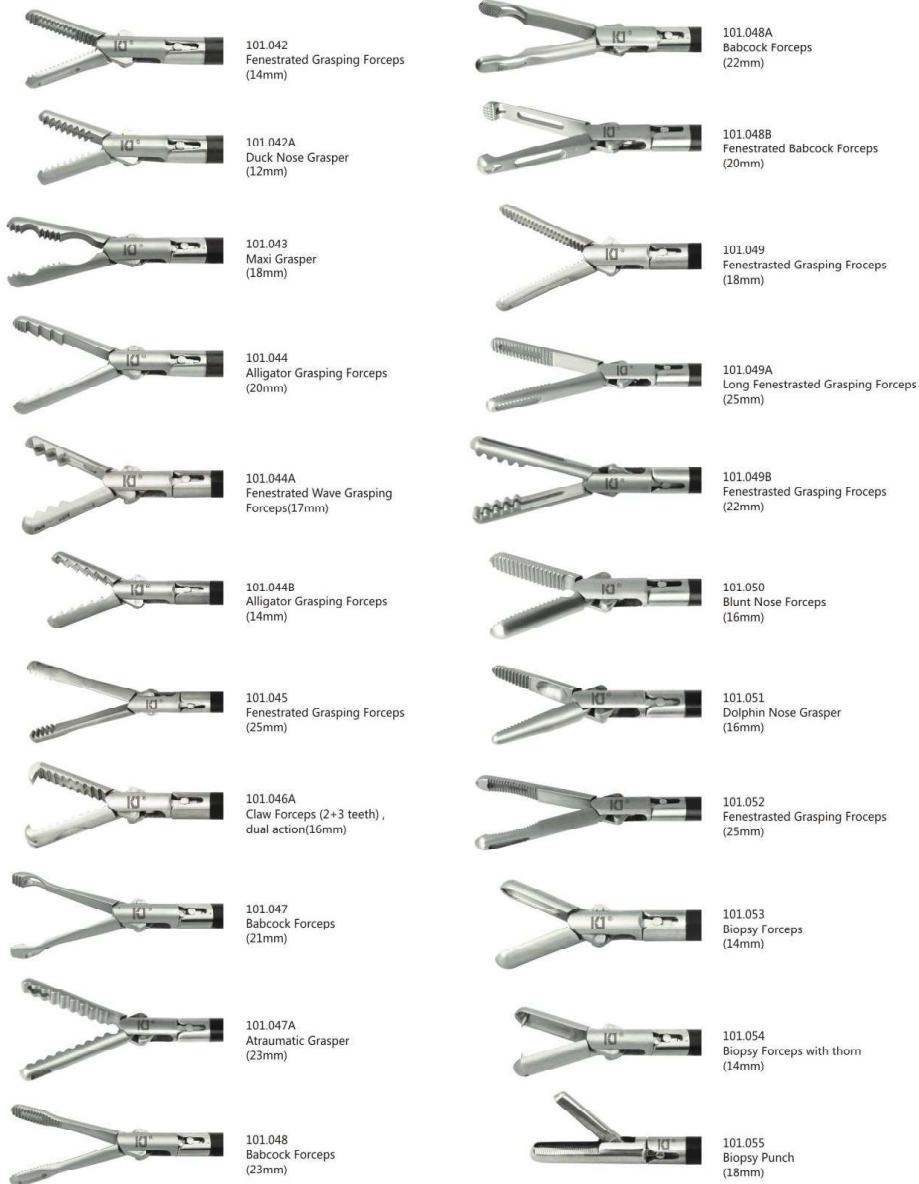

5MM Grasper

Working Length: 220mm/330mm*/450mm *Regular

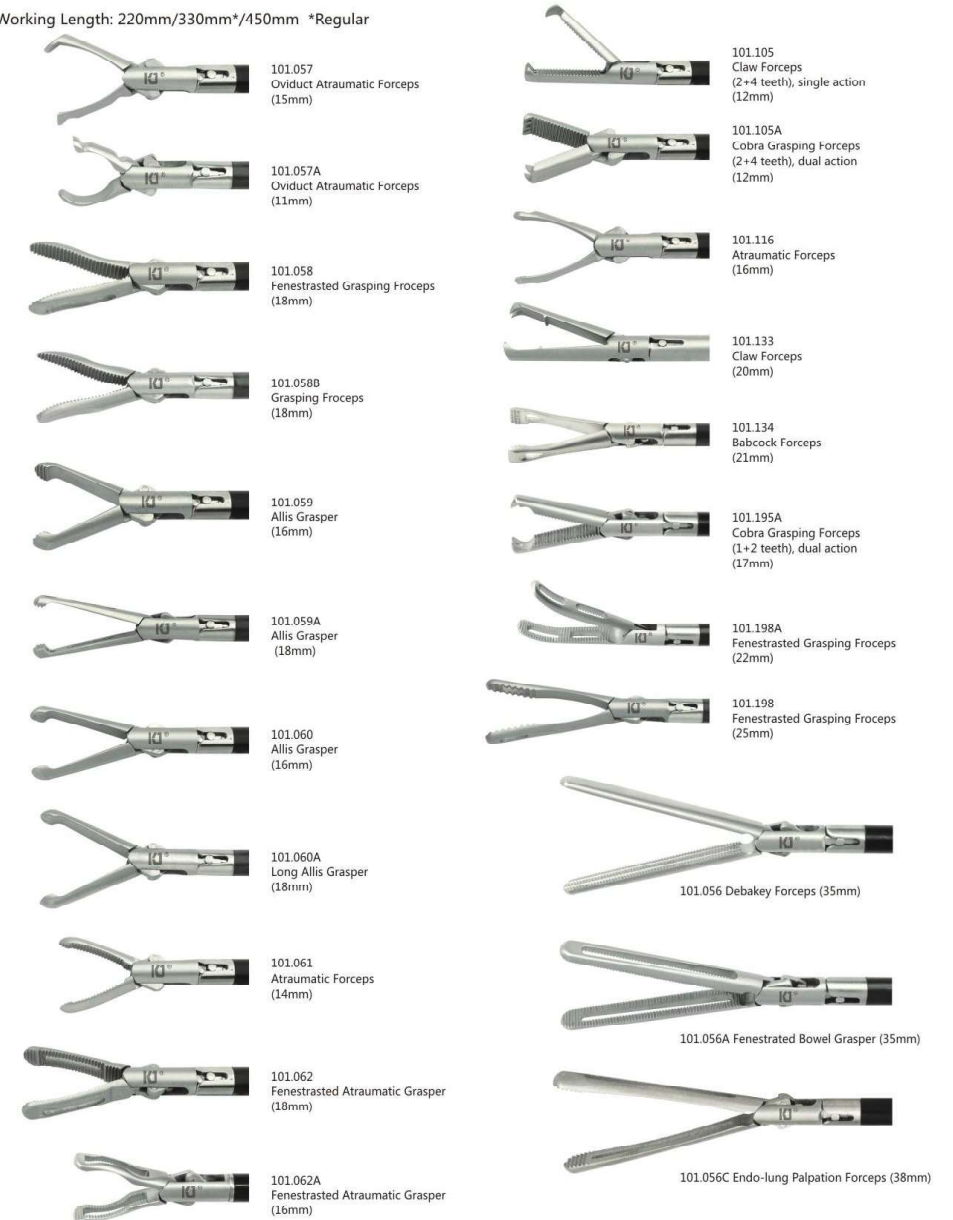

10MM Instrument

Working Length: 330/150mm



Miniature Instruments

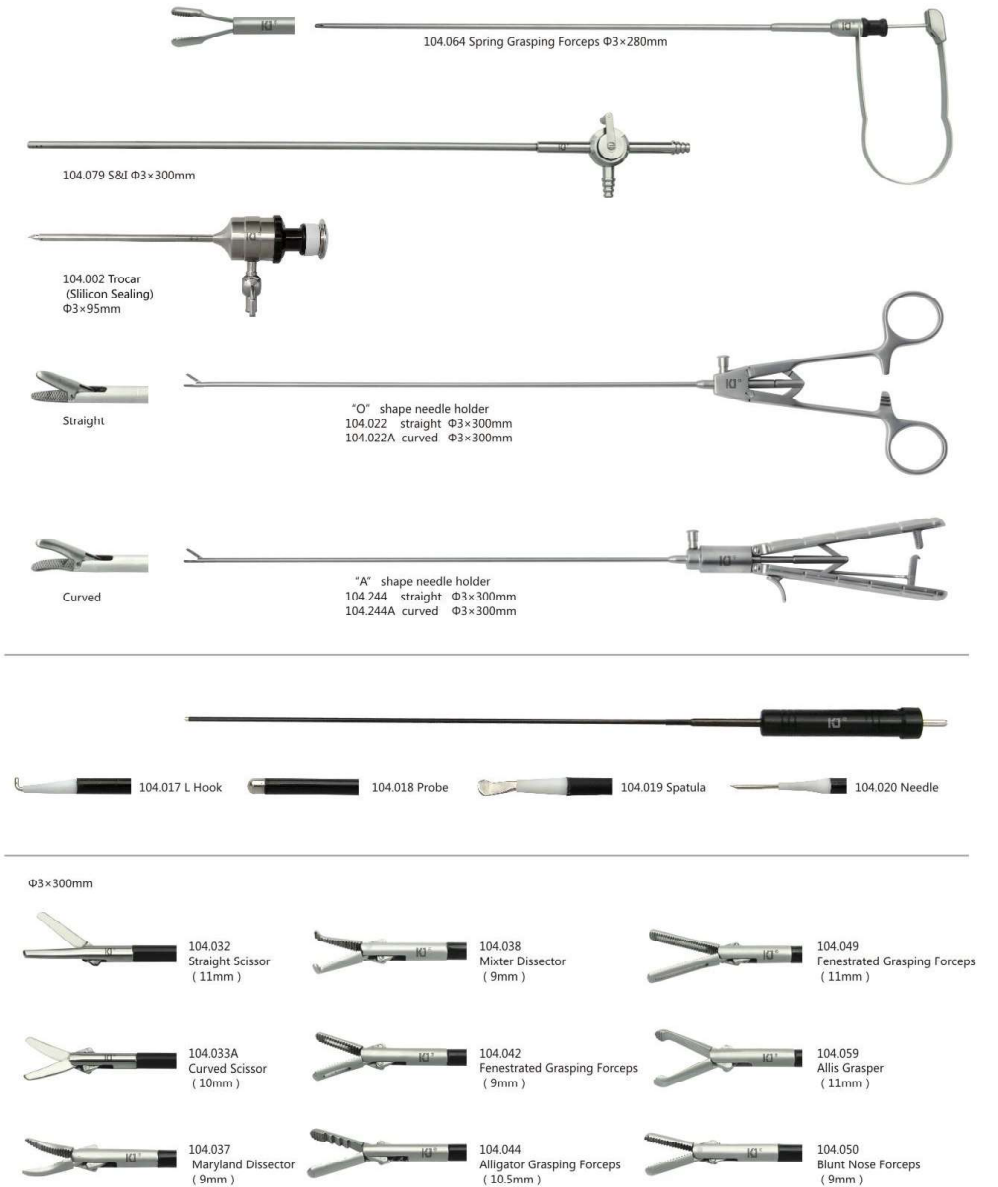

Thoracoscopic instruments

Needle Holder



201.119 Straight
201.119A Curved

Debaquey Grasping Forceps

201.120 Curved, Locking
201.120A Curved, non-Locking



Debaquey Grasping Forceps

201.121 Curved, Locking 25mm
201.121A Curved, non-Locking 25mm



Allis Forceps

201.125 Non-locking 25mm



Fenestrated Grasping Forceps

201.126 Non-locking 25mm



Thoracoscopic instruments

Masher Grasping Forceps



201.127 Curved, Jaw Width 8mm
201.128 Curved, Jaw Width 10mm
201.129 Curved, Jaw Width 12mm

Debaquey Grasping Forceps

201.130 2.5mm Locking
201.130A 2.5mm Non-locking
201.131 3.5mm Locking
201.131A 3.5mm Non-locking



Metzenbaum Scissor



201.133 Curved

Suction

201.134 4 Types



Morcellator



301.004A Morcellator
Φ10×330mm

301.005A Morcellator
Φ15×330mm

301.006A Morcellator
Φ18×330mm

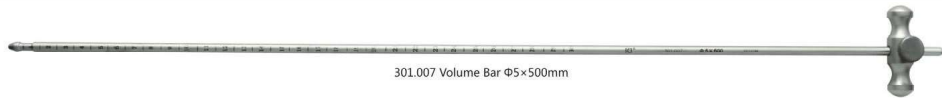

301.007 Volume Bar Φ5×500mm



301.027 Aspiration Needle Φ5×330mm



301.013 Guiding Bar Φ10×370mm



301.029 Knot Pusher Φ5×330mm



301.008 Palpation Probe Φ5×420mm

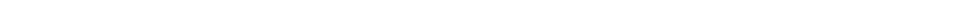

301.020A Myoma Drill Φ5×420mm



301.021A Myoma Drill Φ10×420mm



301.046A Trocar Φ10.5×95mm

301.009A Cannulae Φ15×95mm

301.010A Cannulae Φ18×95mm



301.011A Dilator Φ15mm

301.014A Converter Φ15-Φ10mm

301.012A Dilator Φ18mm

301.015A Converter Φ18-Φ10mm

301.015A-1 Converter Φ18-Φ10mm

301.014A-1 Converter Φ10-Φ15mm

301.047A Converter Φ10-Φ5mm



301.017A Claw Forceps Φ10×420mm

301.018A Claw Forceps Φ5×420mm

301.018A

301.017A



301.019 Uterine Manipulator

301.023 Intrauterine Forceps (Straight)

301.023A Intrauterine Forceps (Curved)



301.024 Controller



301.025 Handle

301.036 Motor

Cord

Cord

Uterine Manipulator



Multifunctional Uterine Manipulator

301.027 Multifunctional Uterine Manipulator



Uterine Manipulator



Probe Separator



Gynecology Surgical Instruments

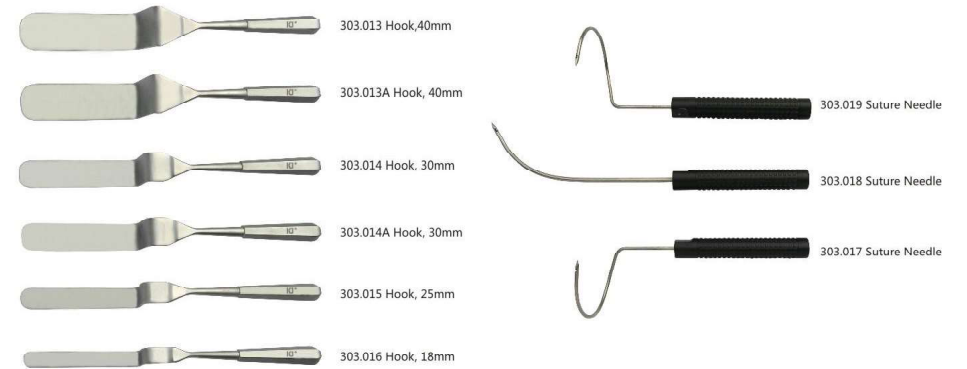

Laparoscope



Laryngoscope

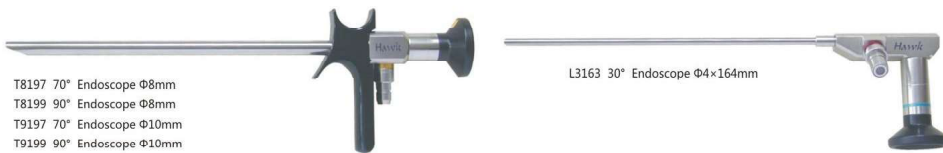

Arthroscope



Otoscope

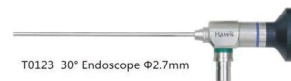

Hysteroscope



Hysteroscope



Hysteroscope For Inspection



Systo-Urethroscope

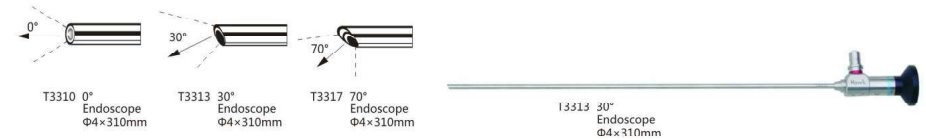

Uretero Renoscope

Y1430 F8.5×430mm

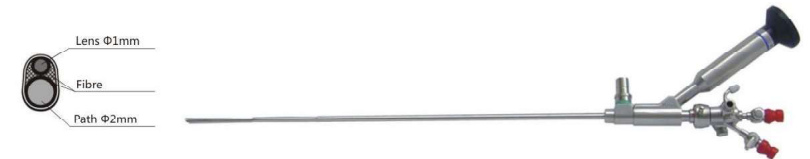

Sterilization Case

